

<N 5! J

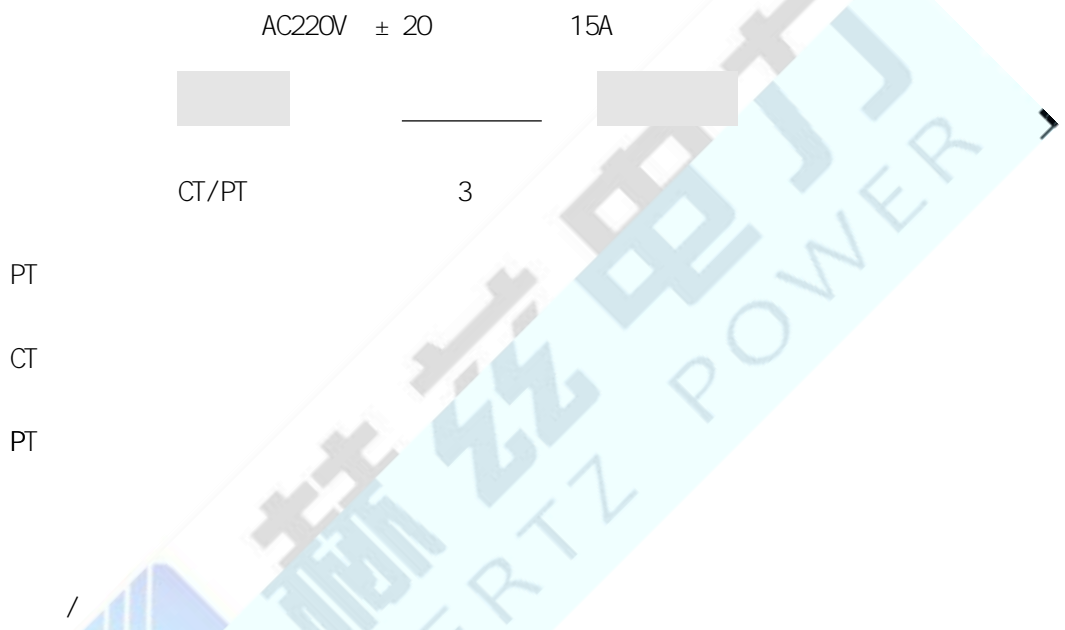

HZFA-V





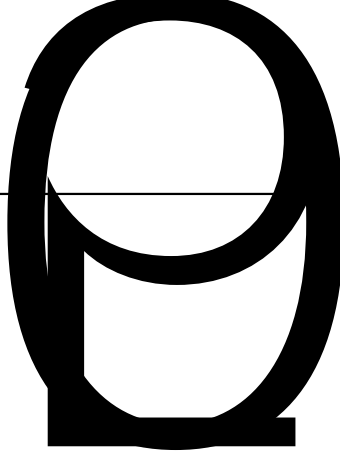

CT/PT " " " 5 10 15 " " "

" " " " " " " " "

220V

2000

RS232

U

20Kg

| | | | | |
|----|------|---------|------|--------|
| CT | 220V | 0—1000V | 3KVA | < 0.5% |
| PT | 220V | 0—330V | 3KVA | < 0.5% |
| CT | 220V | 0-8V | | < 0.5% |
| PT | 220V | 0—1000V | | < 0.5% |
| CT | - | | | |



220V

CT PT U

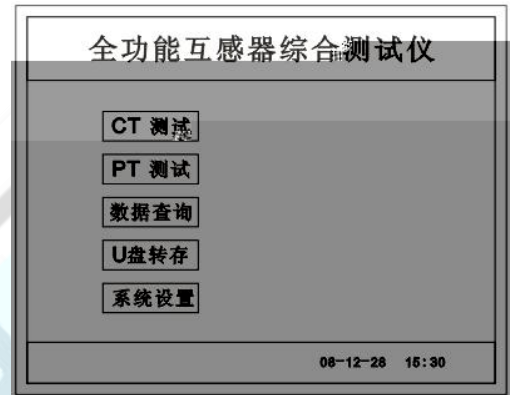

A.



CT



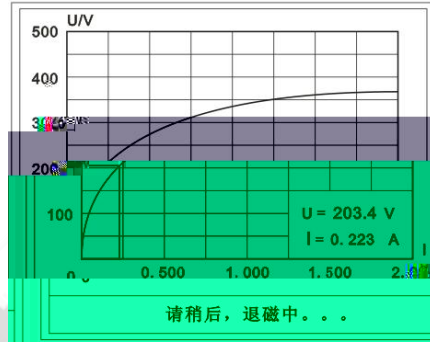
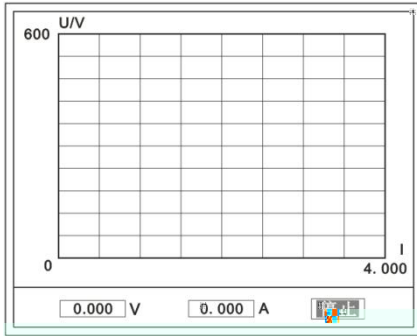
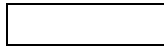

d.



()

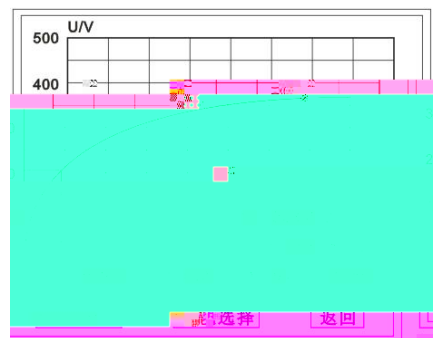



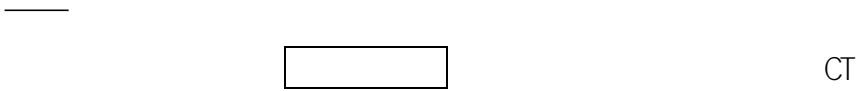

b.



c.

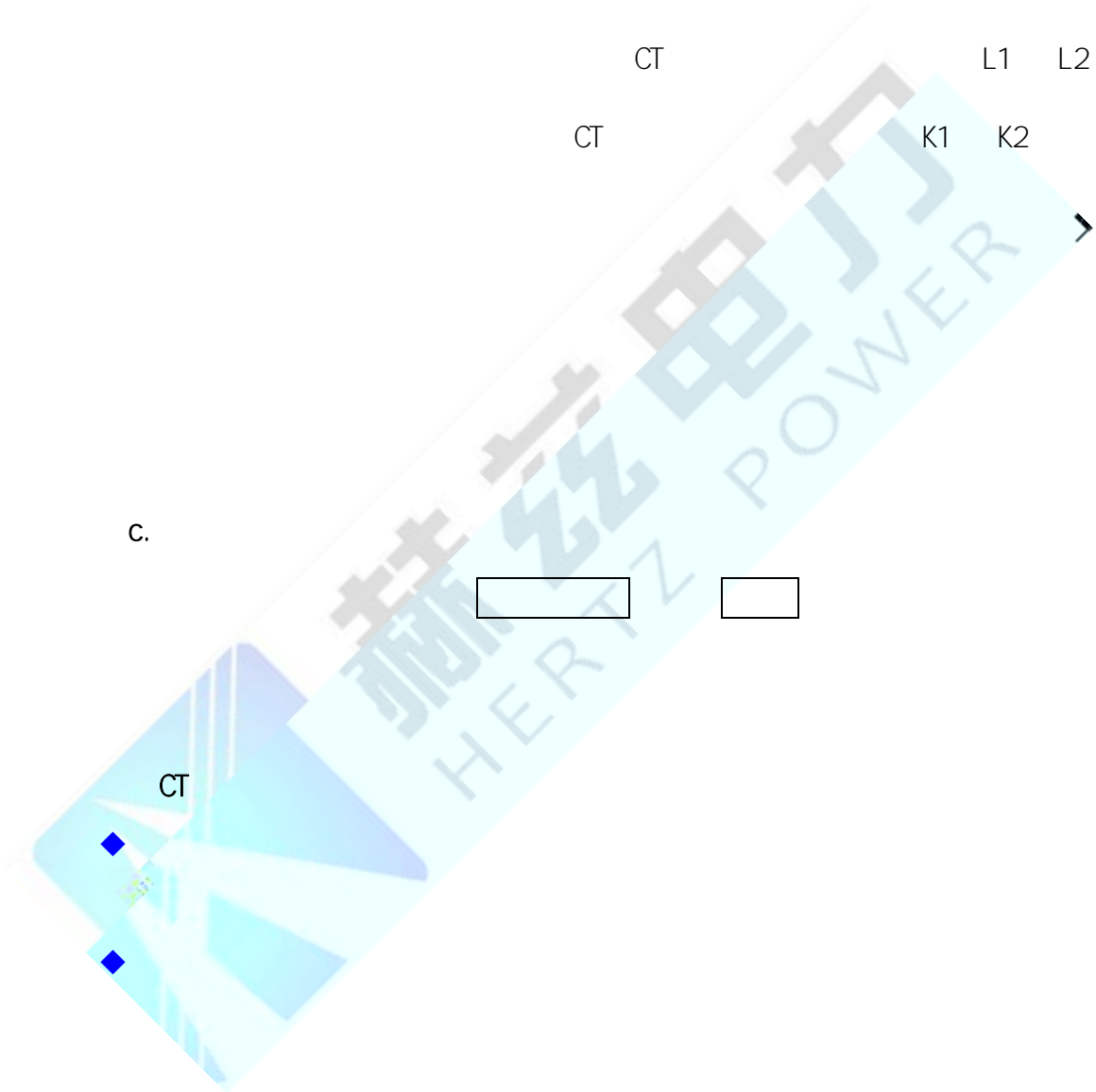

e.

5 200A

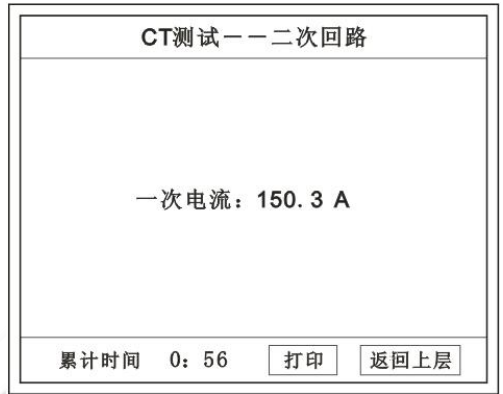

E.

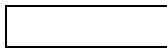

4. PT

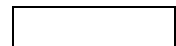
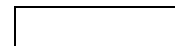

CT

CT

A. PT

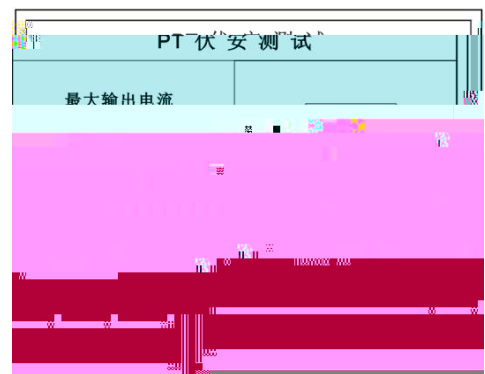
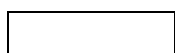

a.



0 - 3 A



0~330V



b.



B. PT

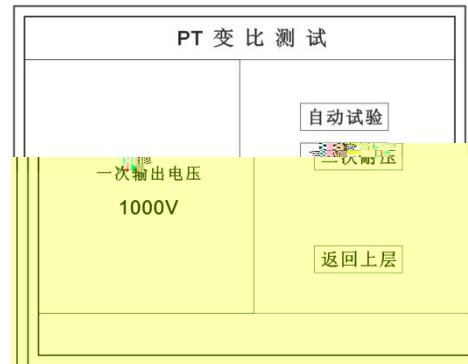
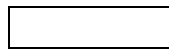

a.



0 - 1000



5

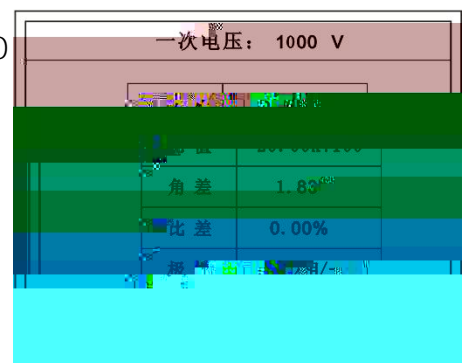

b.

PT

a x

c.

5

1000V



5.

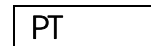
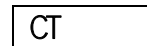

A. CT

a.

b.

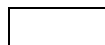
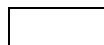
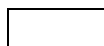

| N | 编号 | 相序 | Kn | 时间 | 类型 |
|---|--------|----|----|----------------|----|
| 1 | ABC001 | A | | 09-05-01-15:23 | 变比 |
| 2 | ABC001 | A | 1 | 09-05-01-15:23 | 变比 |
| 3 | ABC001 | A | 1 | 09-05-01-15:23 | 伏安 |
| 4 | ABC001 | A | 2 | 09-05-01-15:23 | 伏安 |
| | | | | | |
| | | | | | |
| | | | | | |
| | | | | | |
| | | | | | |



6. U

U

5

U

U

U



U

U

7.



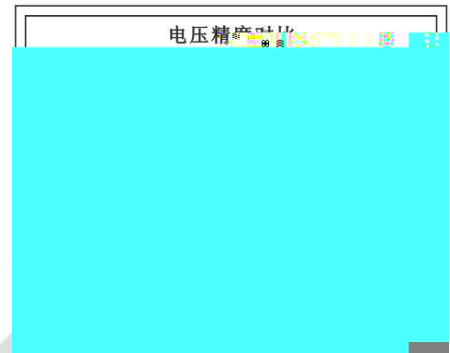

赫兹电力
HERTZ POWER

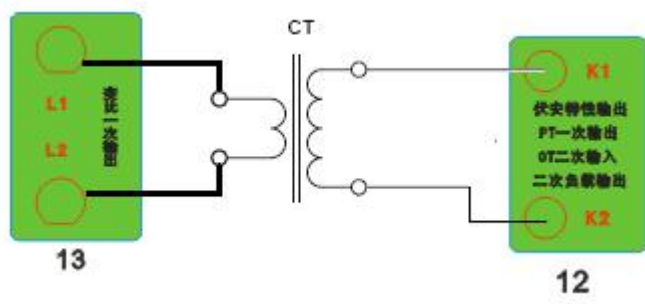
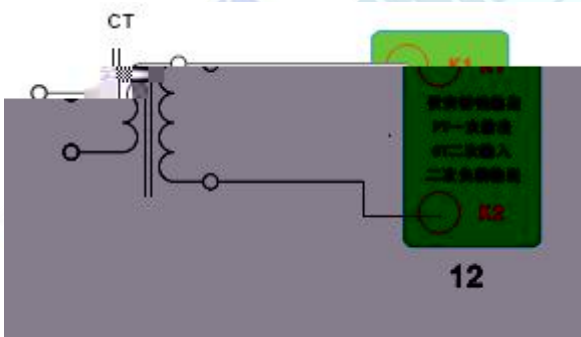

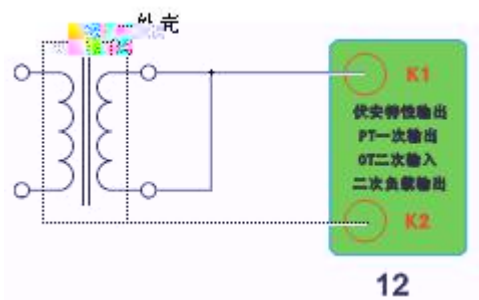
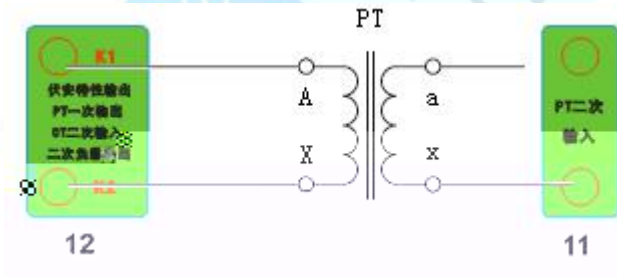
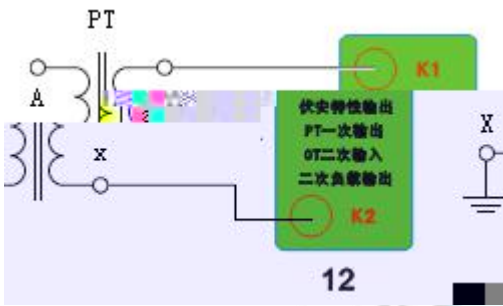
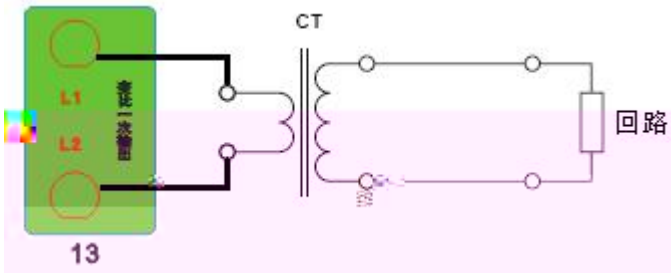

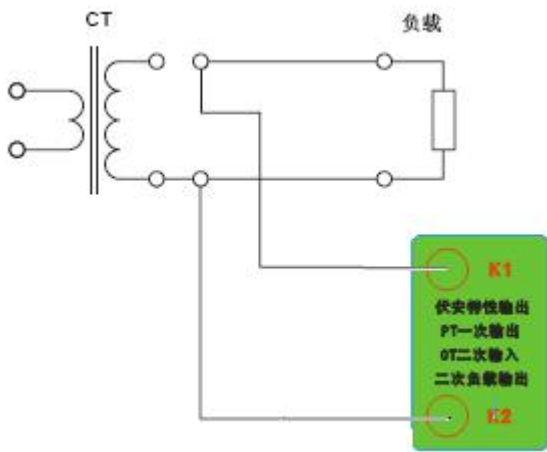
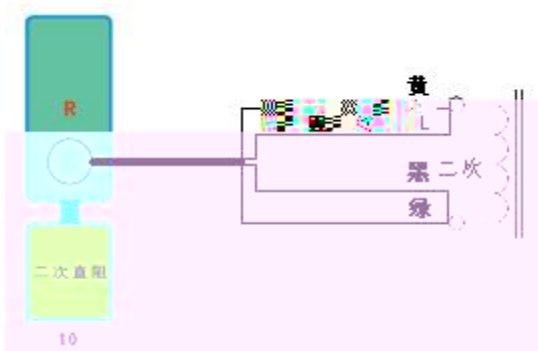

"

"

"

"

1

2

1.

2

1

2

3

2

24

027-83267669

24

48

4