

ZGF-120kV/2mA

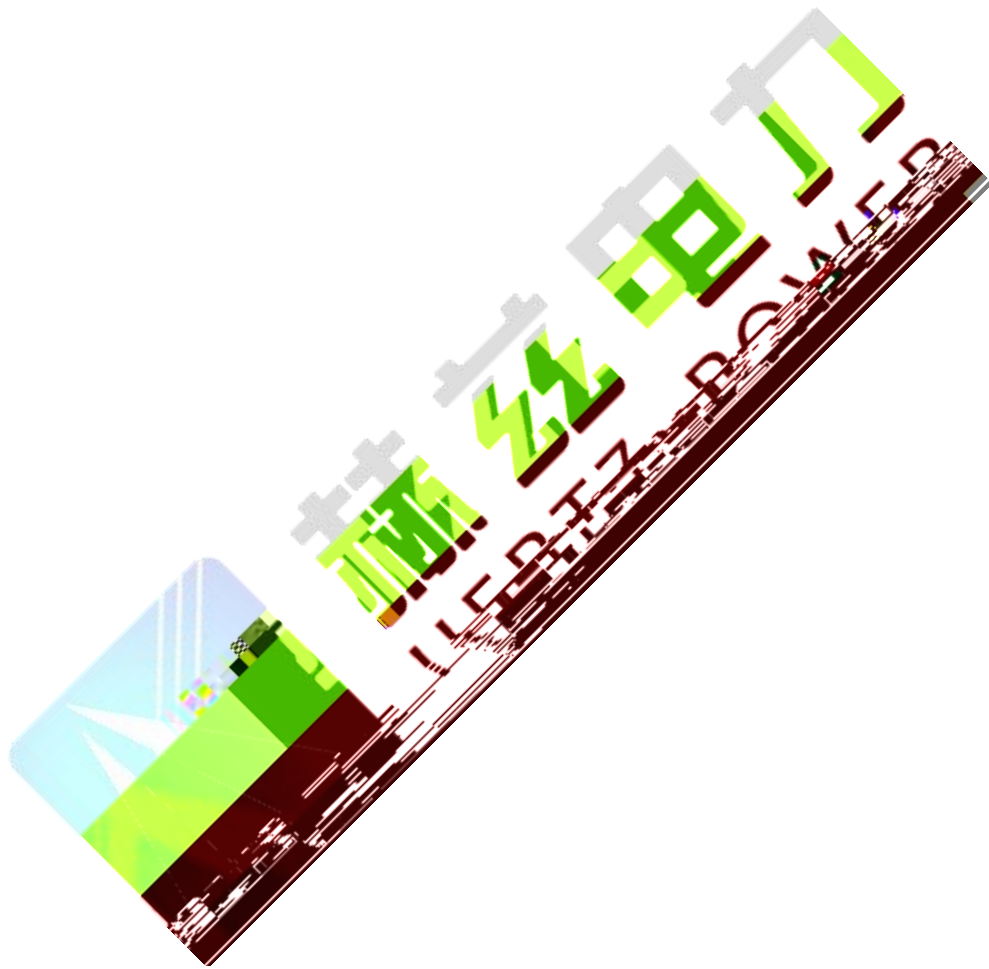



赫兹电力
HERTZ POWER

产品宗旨：技术领先，质量可靠，轻便易用

服务宗旨：快速响应，**达到满意，超过期望**

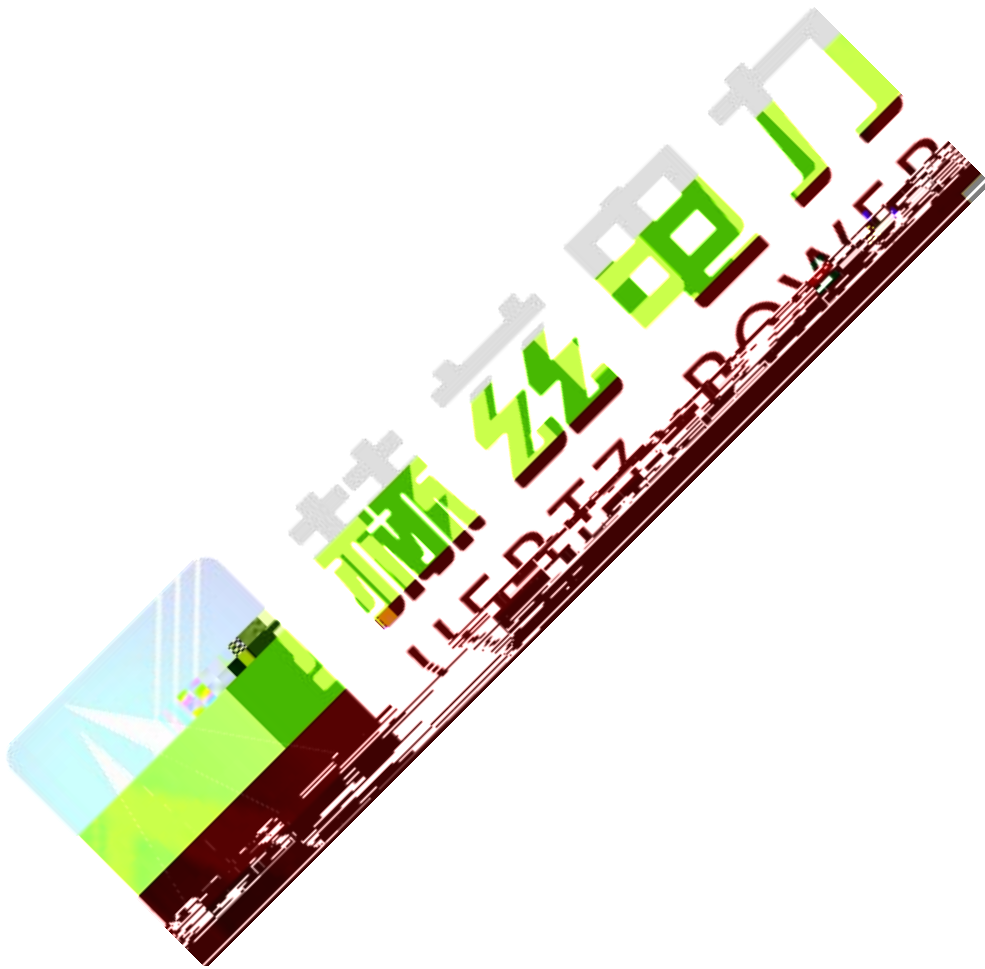

1.1

1.2

1.3

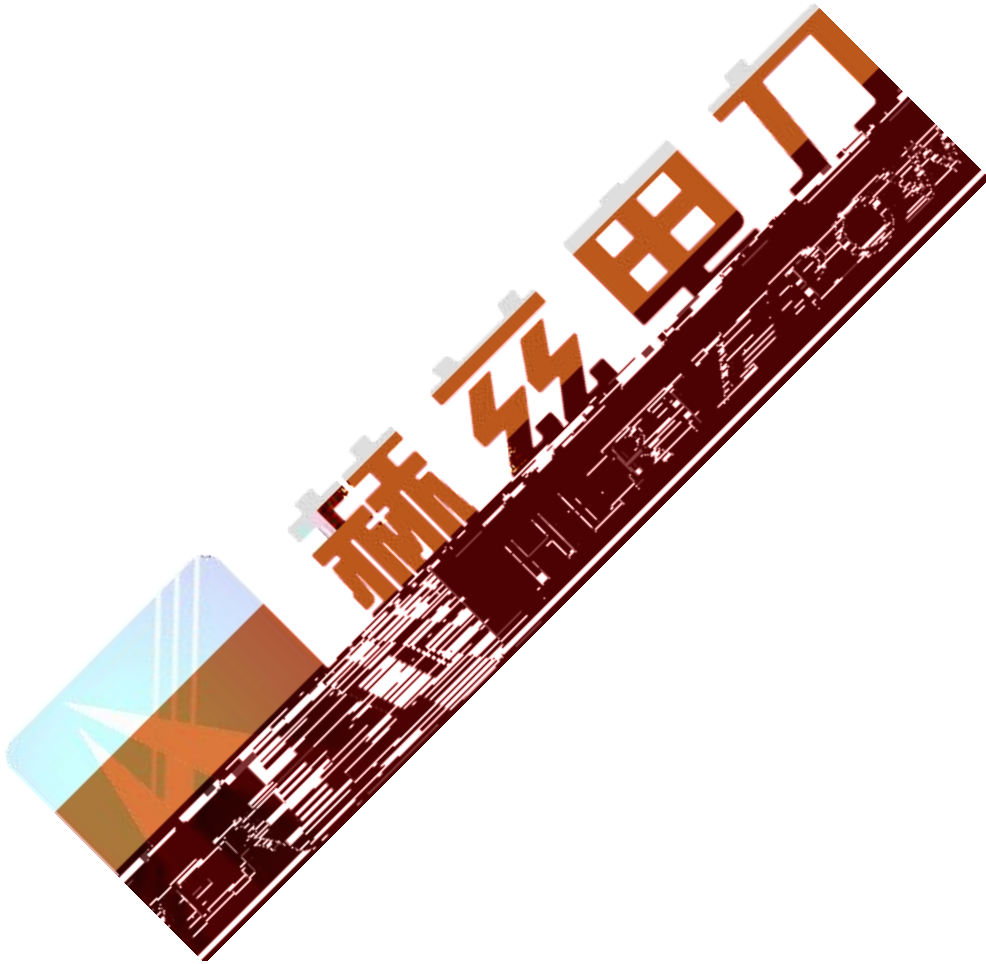





赫兹电力
HERTZ POWER

产品宗旨：技术领先，质量可靠，轻便易用

服务宗旨：快速响应，**达到满意**，**超过期望**

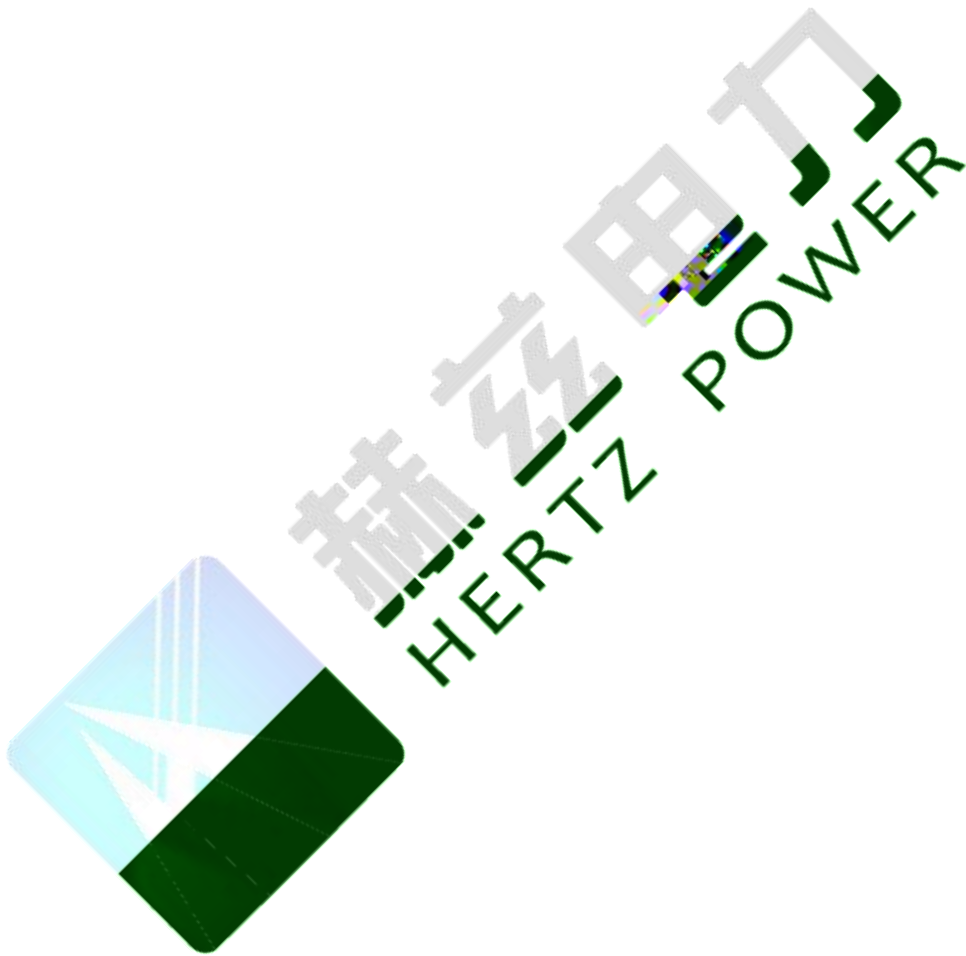

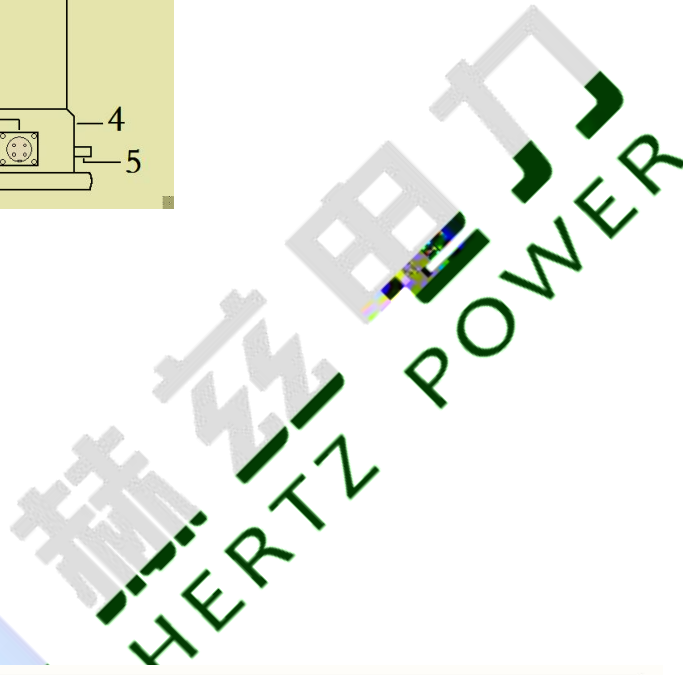
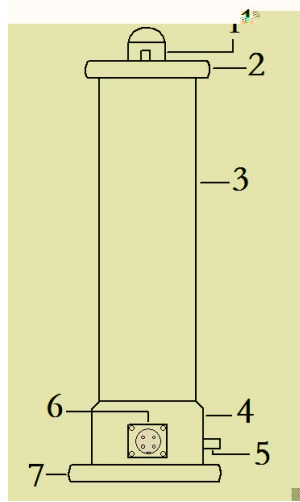

1.7

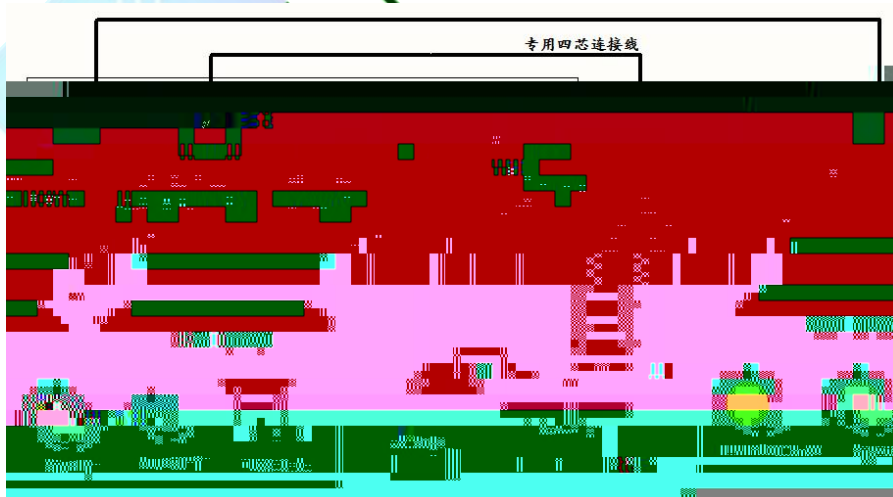

2.1

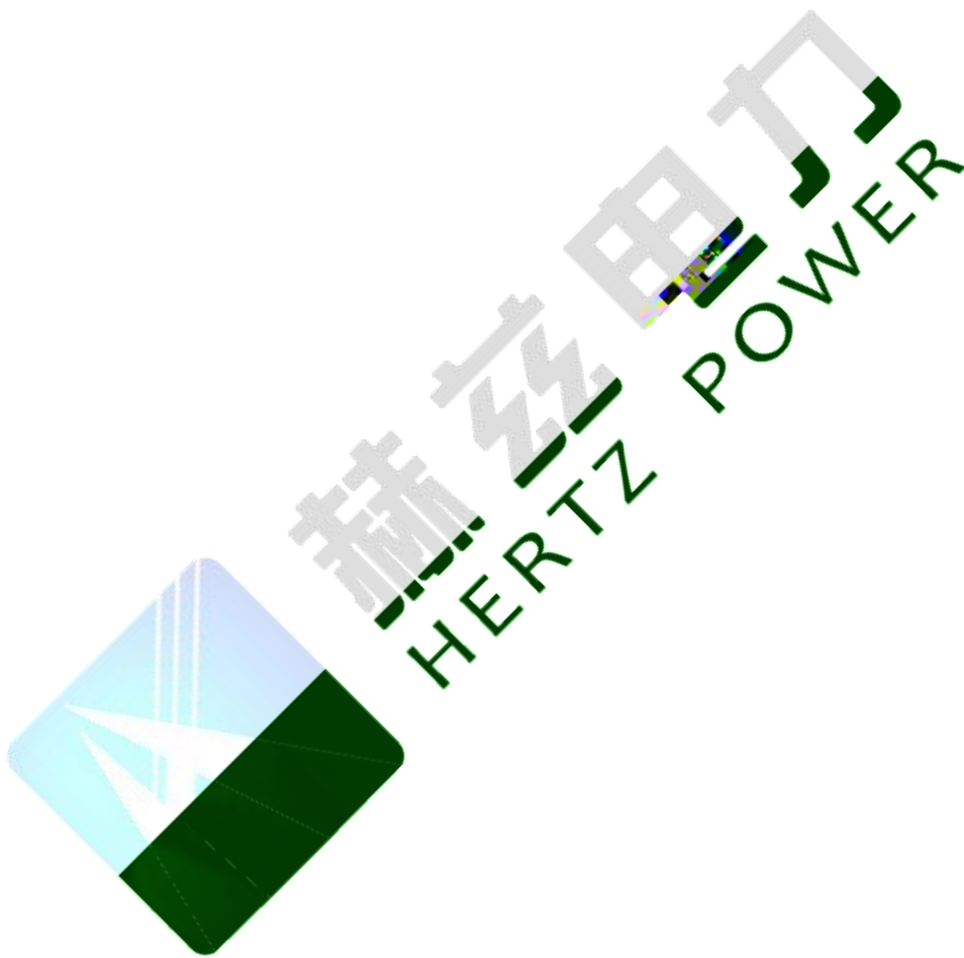

3.1

3.2

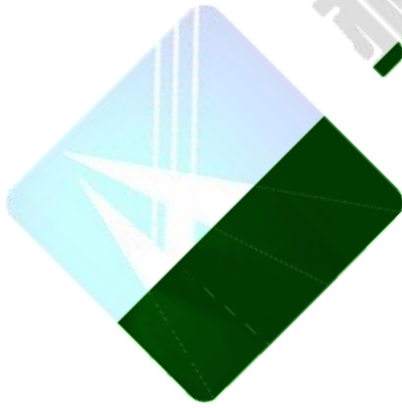

赫兹电力
HERTZ POWER

3.3



赫兹电力
HERTZ POWER

产品宗旨：技术领先，质量可靠，轻便易用

服务宗旨：快速响应，**达到满意，超过期望**

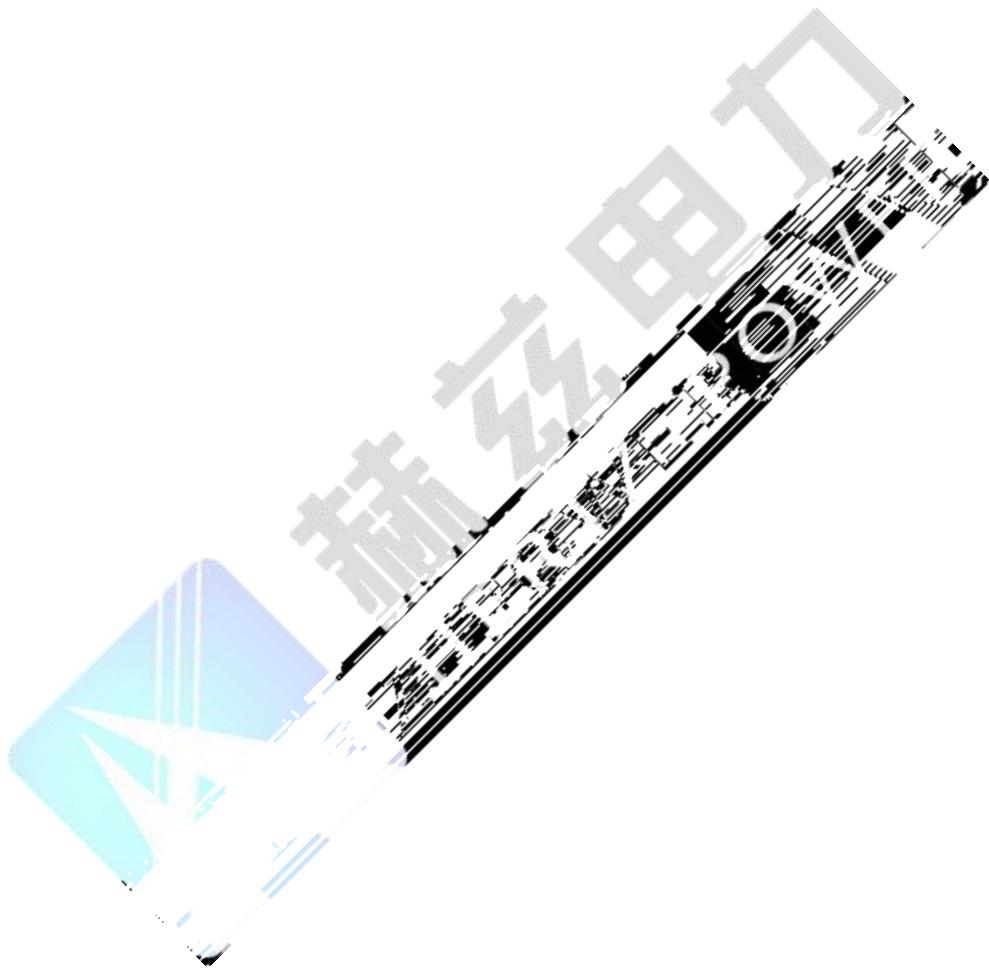



3.5

I I I_o

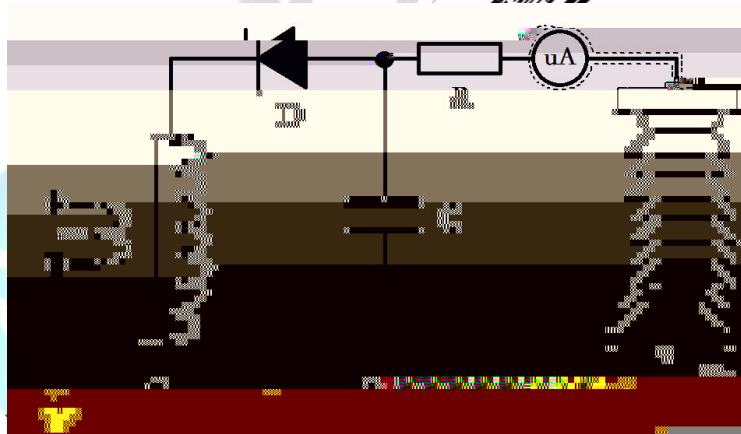

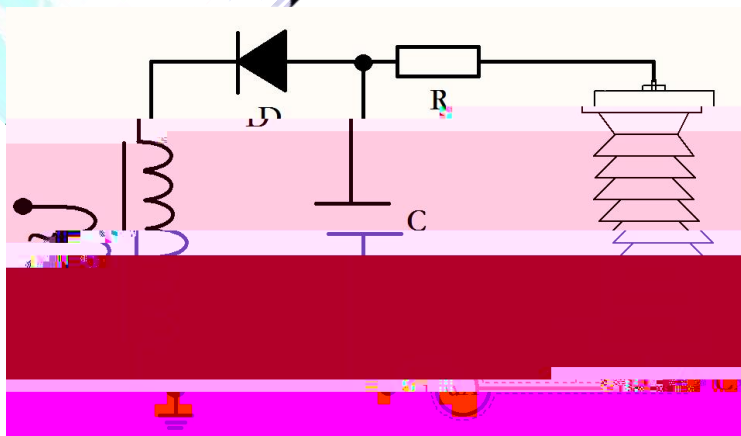
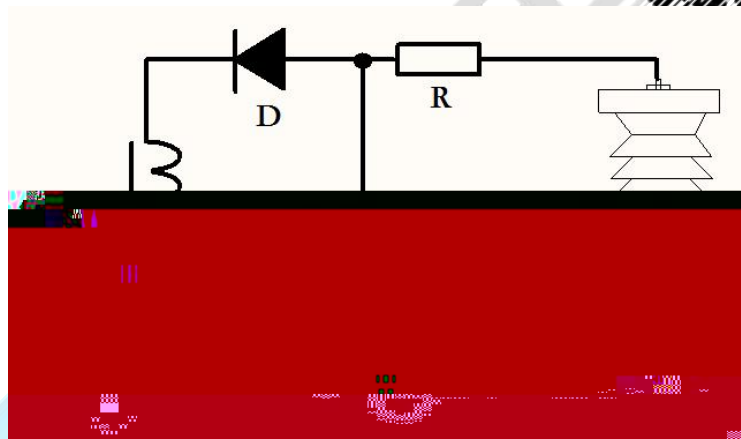
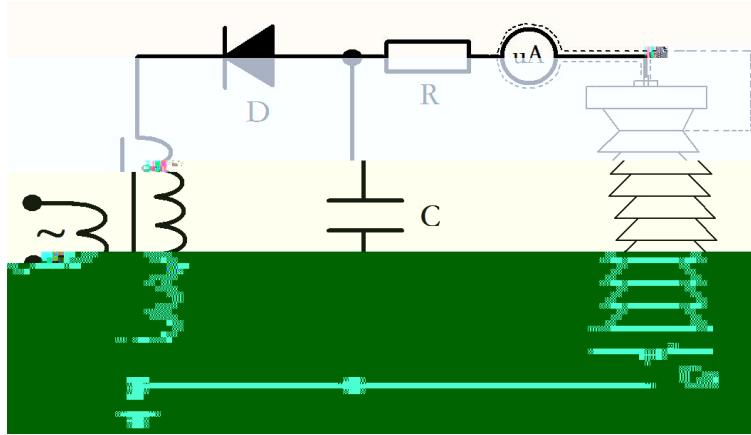



赫兹电力
HERTZ POWER

产品宗旨：技术领先，质量可靠，轻便易用

服务宗旨：快速响应，**达到满意，超过期望**

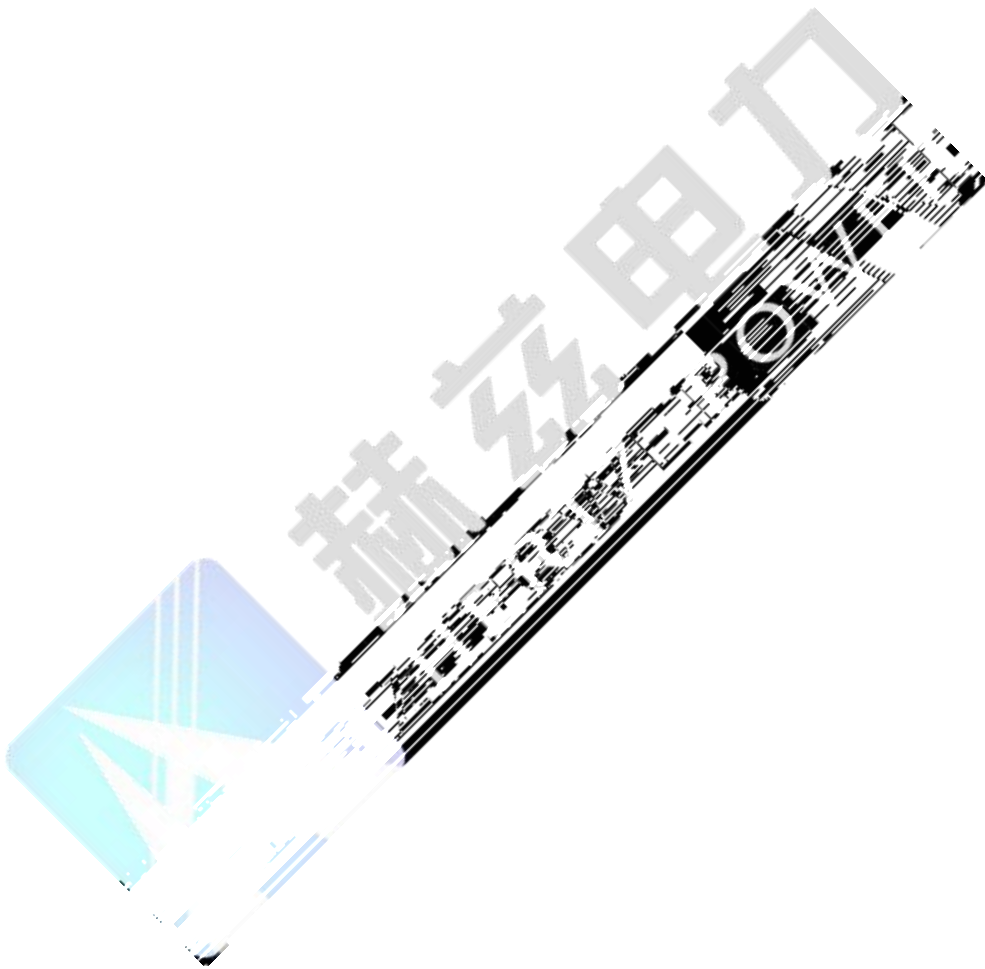



赫兹电力
HERTZ POWER

产品宗旨：技术领先，质量可靠，轻便易用

服务宗旨：快速响应，**达到满意，超过期望**

