

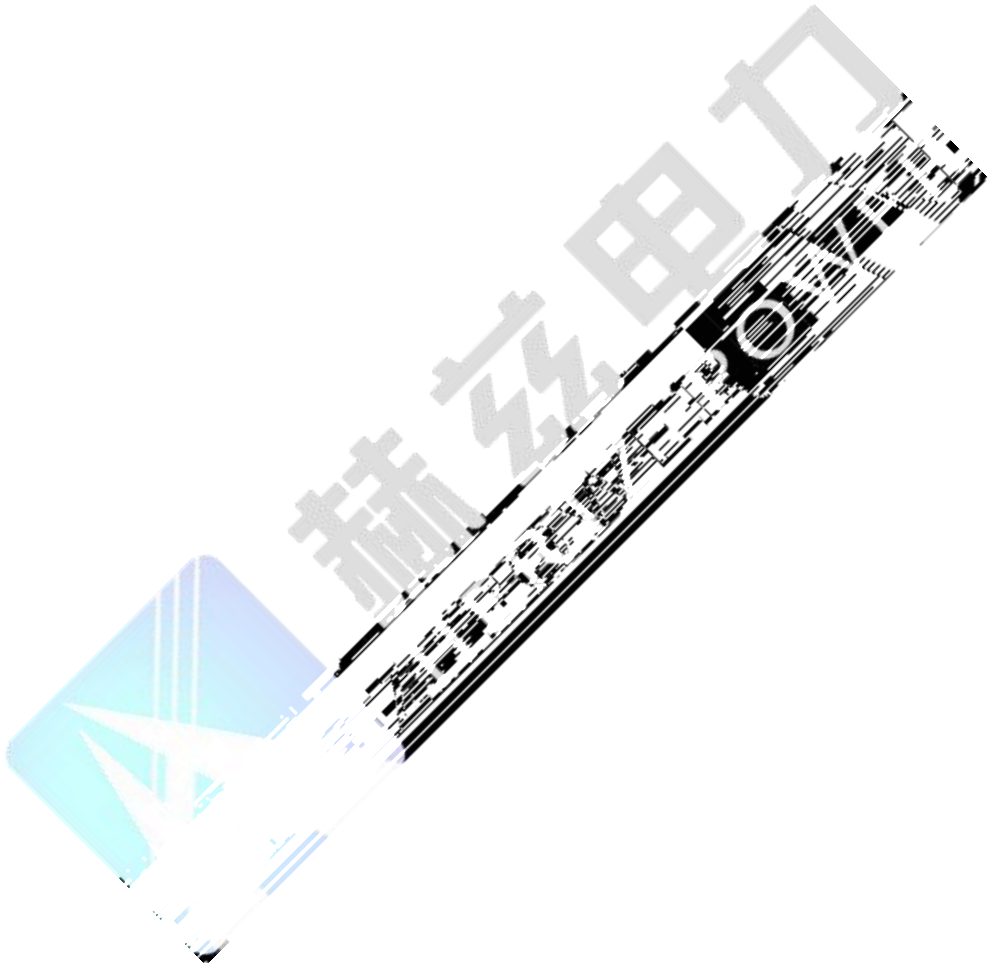

赫兹电力
HERTZ POWER





赫兹
TZ VER

服务 速响应 达 超过

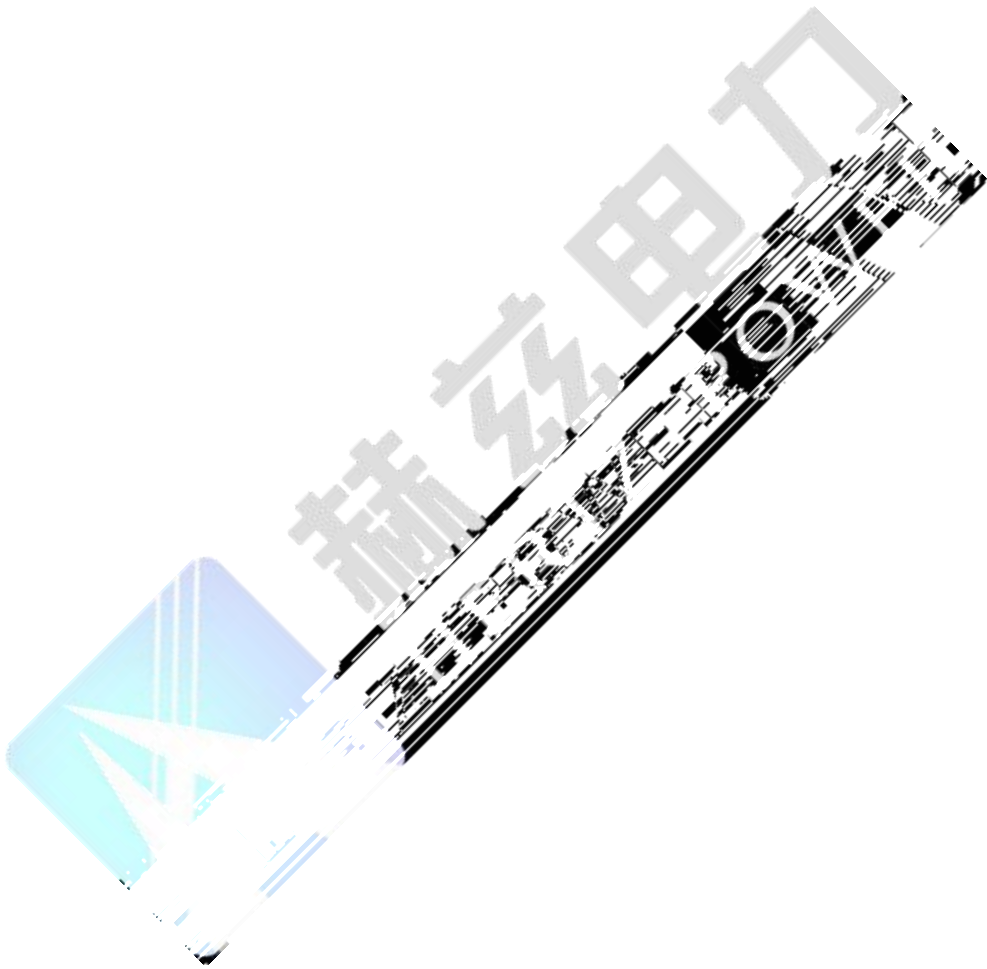

14. : 55

15. : 30min

:

	kVA	V	kV	mA	kV	mm	kg
GTB-1.5/50	1.5			30		240×180×380	13
GTB-3/50	3			60		330×240×380	

50

70

200

5

200V

1

2

225

027-83267669

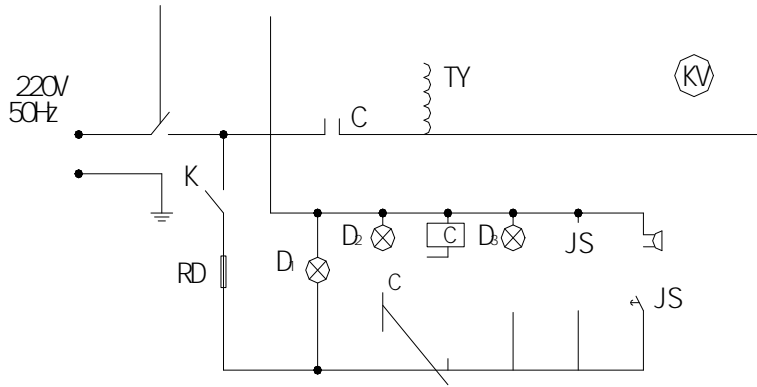

1

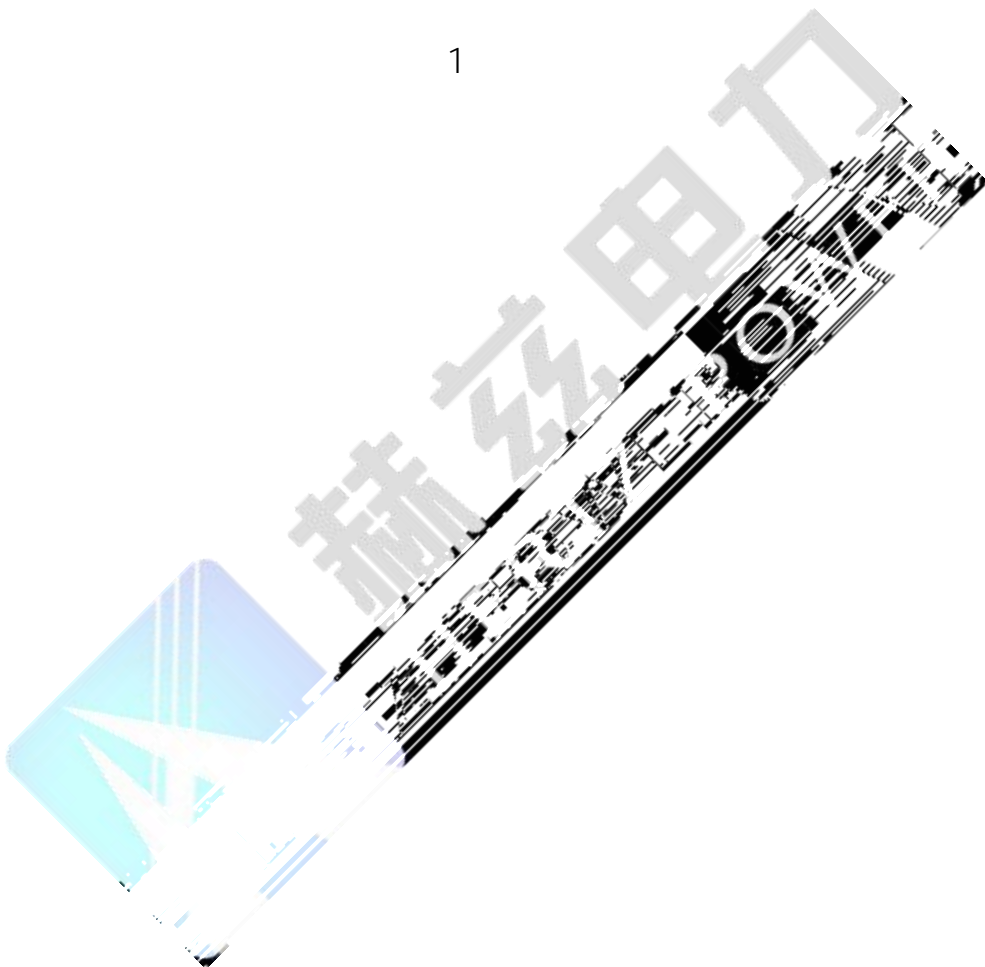



“ ” “ ”

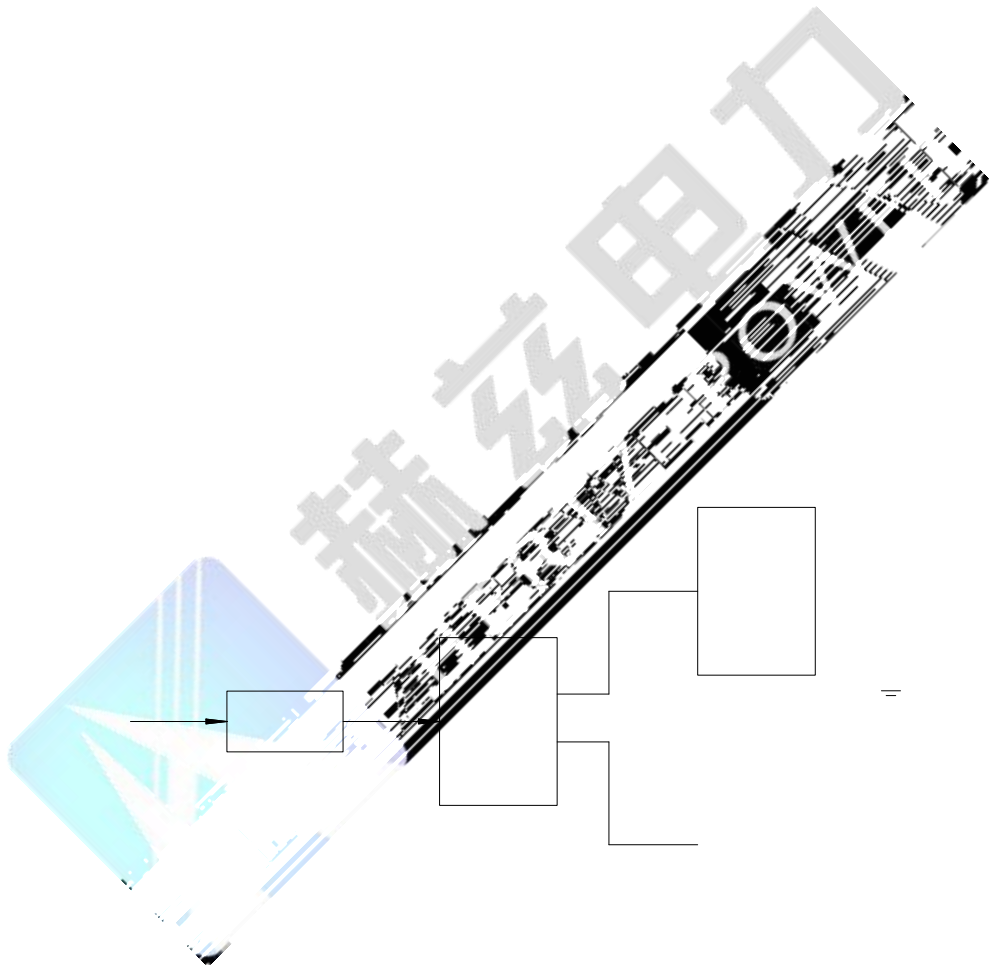

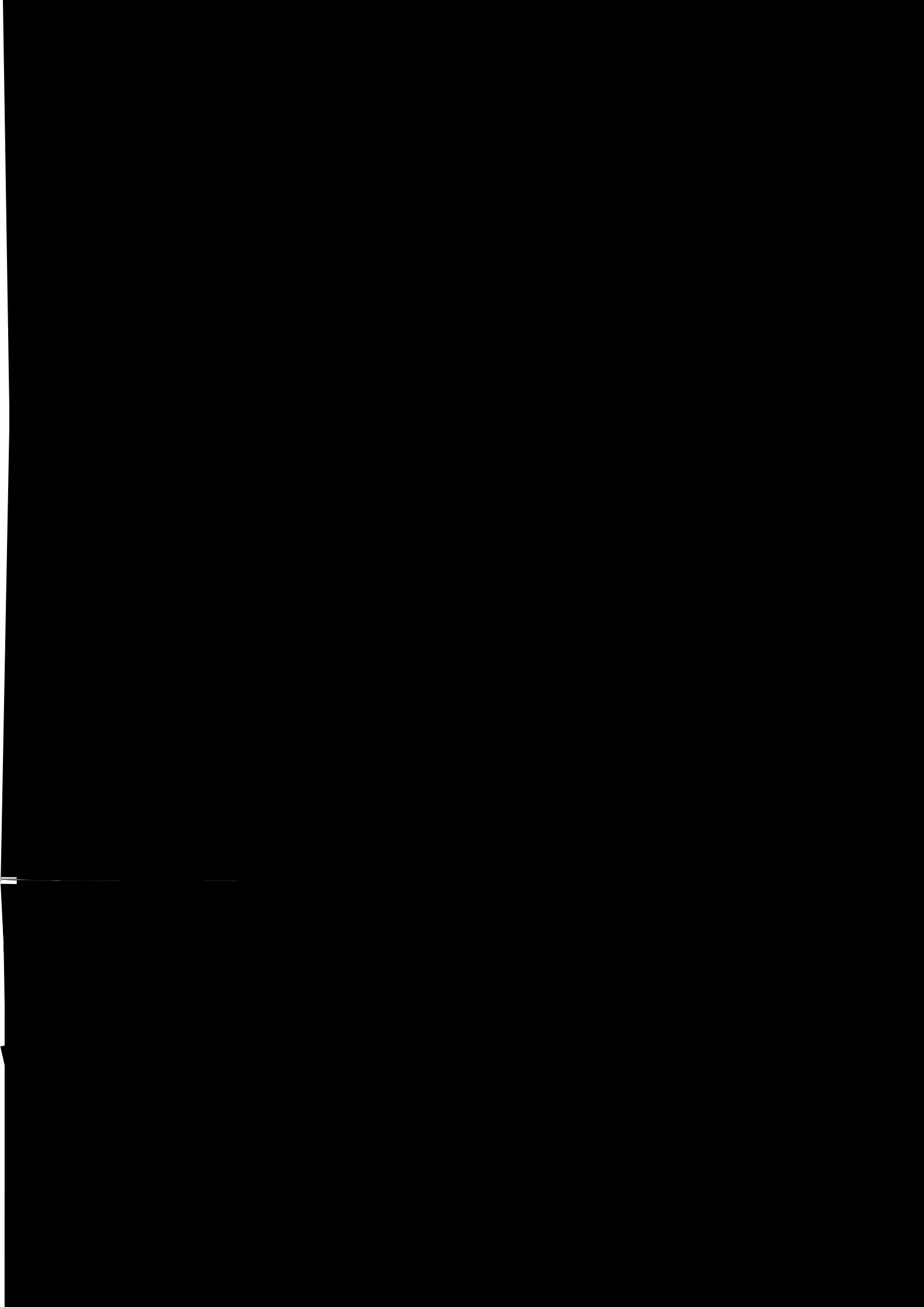

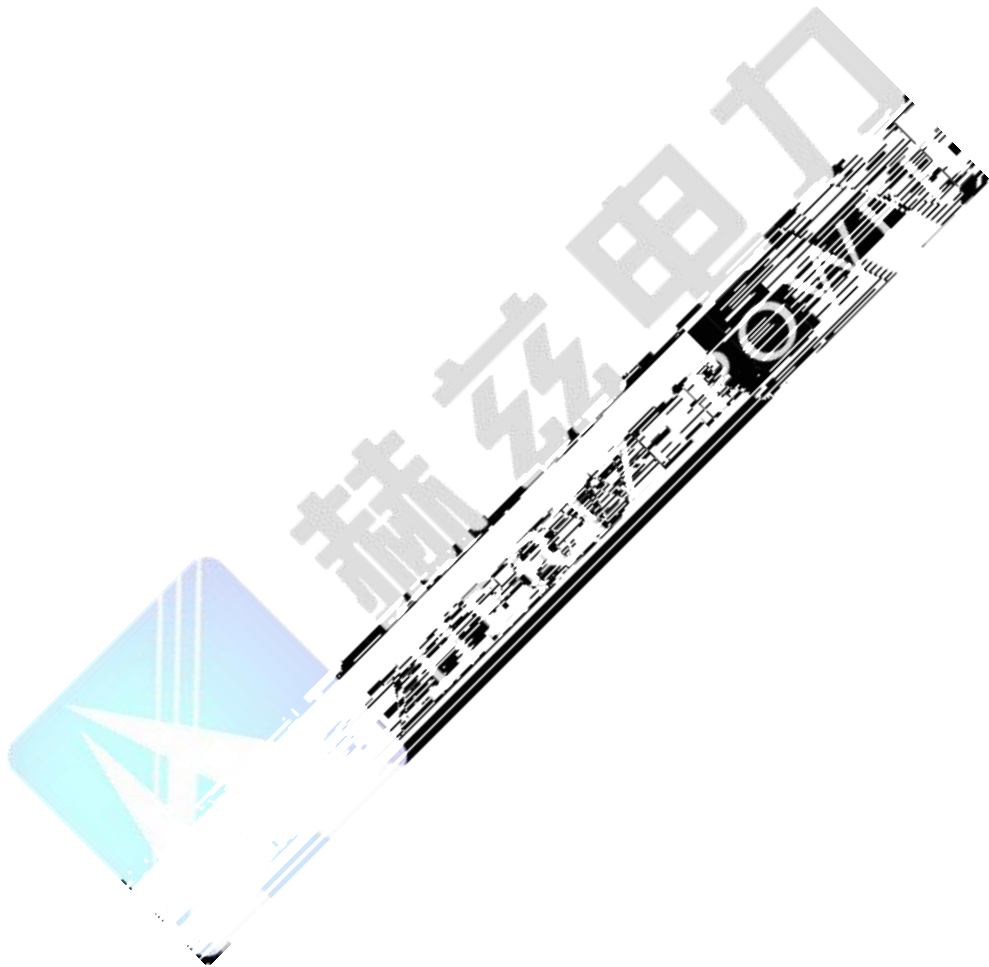

P₀—

P—

P₀=P

1

	kVA						mm	kg
			V	Hz	V	A		
HZTC	3	1	220	50	240	13.6	300*400*220	17
HZTC	5	1	220	50	240	22.7	300*400*230	20
HZTC	10	1	220	50	240	45.5	410*540*680	28
HZTC	15	1	220 380	50	240 430	68 39	410*540*680	35
HZTC	20	2	380	50	430	52.6	410*540*680	40
HZTC	30	2	380	50	430	78.9	570*630*1100	65
HZTC	50	2	380	50	430	131.5	620*650*1600	100

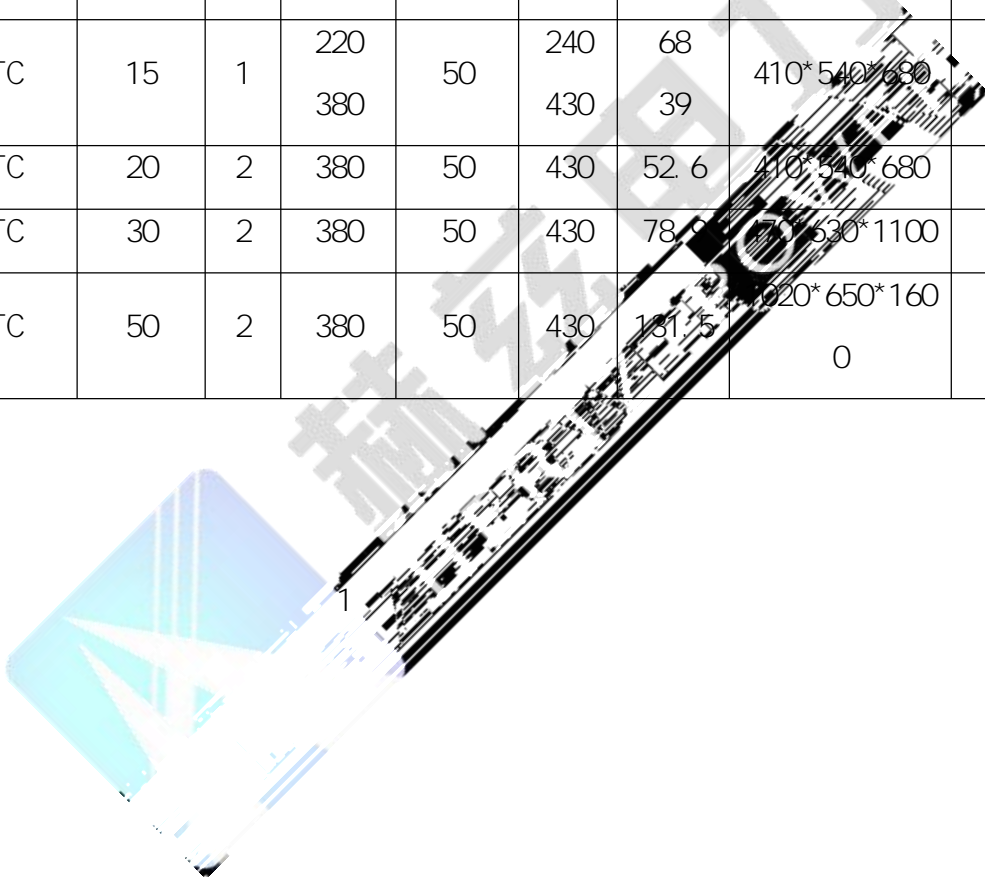

5—1

5—2

5—3

“ S”

5—4

