

B 220kV

%

%%

\$")

%&

\$")

6

%'

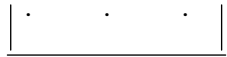

)\$<nw)!

%(

&)\$

%)

%

%*

&)aa⁸

%+

\$")

%,

%-

7JH

7JH

; =G

DH

%%\$

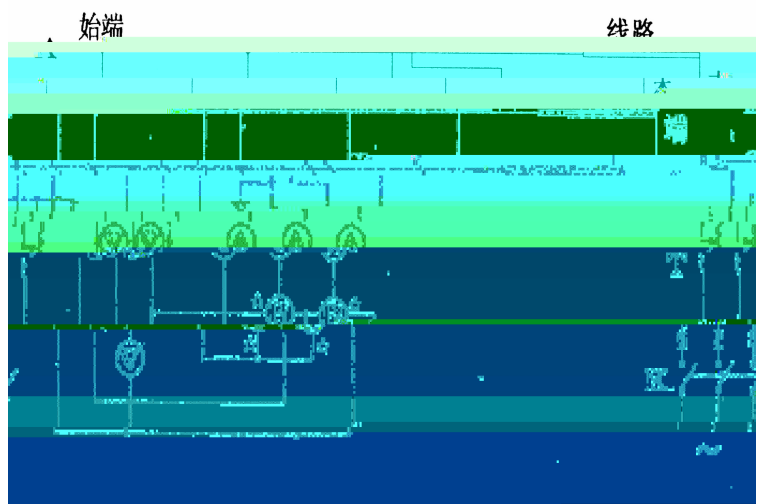

&

&" %

6%

fl Ł

6%

_____ fl # Ł

$\sqrt{\quad}$ fl # Ł

$\sqrt{\quad}$ fl # Ł

⊗

⊗

&\$\$

\$" \$-ž^\$" (# #

\$" \$*ž^\$" ' # #

\$" \$' ž^\$" & # #

_____ +\$v ,)v

&" &

6& .

&\$\$

U

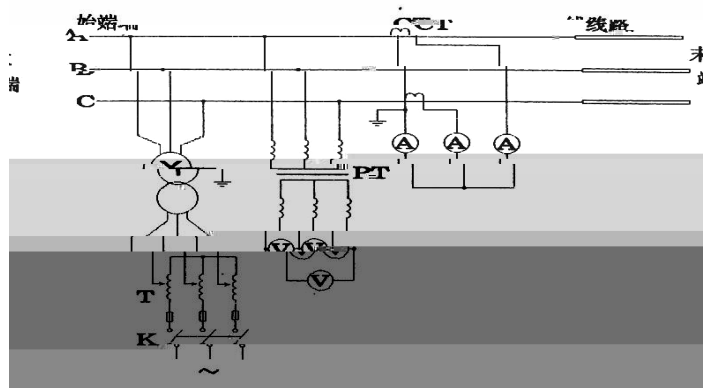

&" (

6(.

0

#

* %\$

M1 \$" *

\$" , LM

M2M

&")

6)

\$.

* A A A A

始端 CT 线路 末端

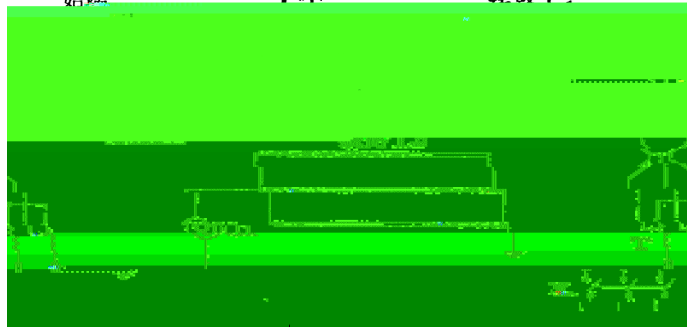

6)

√ _____

_____ #

_____ #

√ _____ #

,)\$\$ # fl 七

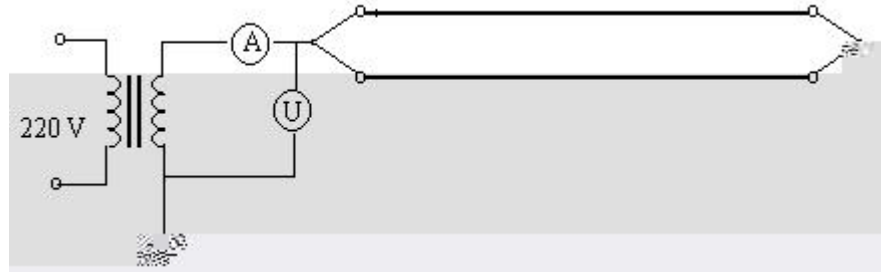

— y %\$

* %\$

\$" * \$" , 七

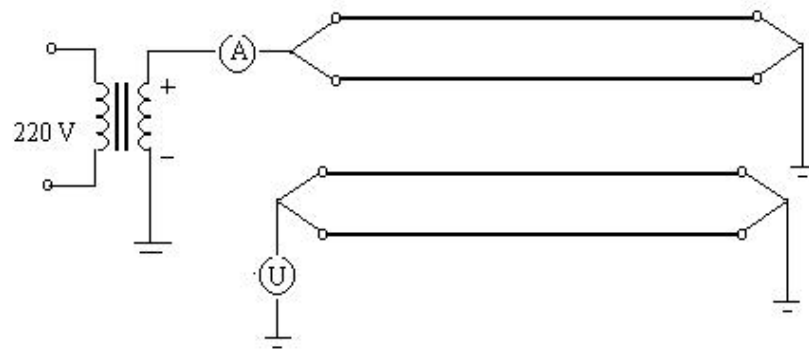

—

\$(! \$" * fl

七

(
("%

("'
(" "% \$" &) » &) \$» w &
(" "% & "\$ \$" Ç : %Ç : w &
(" "' "\$ %' * \$V w &
(" "% (\$5

&5

("(
(")

(" *
(" * "%

(" * "&
(" * "'
(" * "(
)
) "%
) "&

&) I

fI %\$ \$I

U

V

%\$ \$I

W

X"

% &

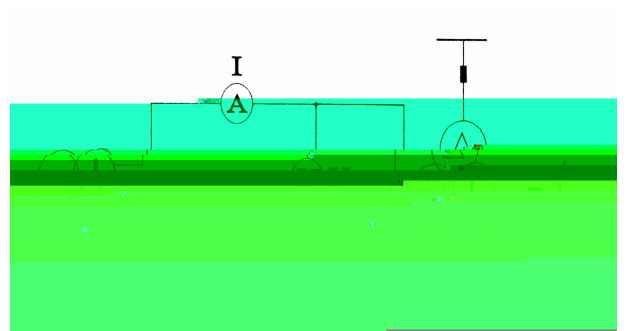

6%%M#M# M# #M M# #

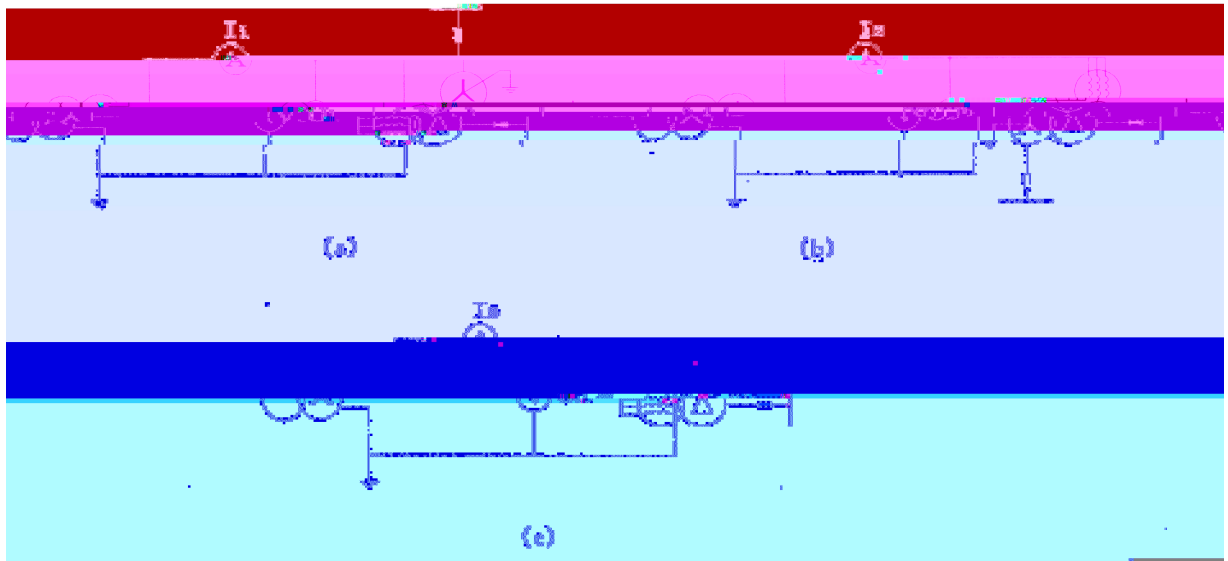

6% $M_{\#}N_{\#}$

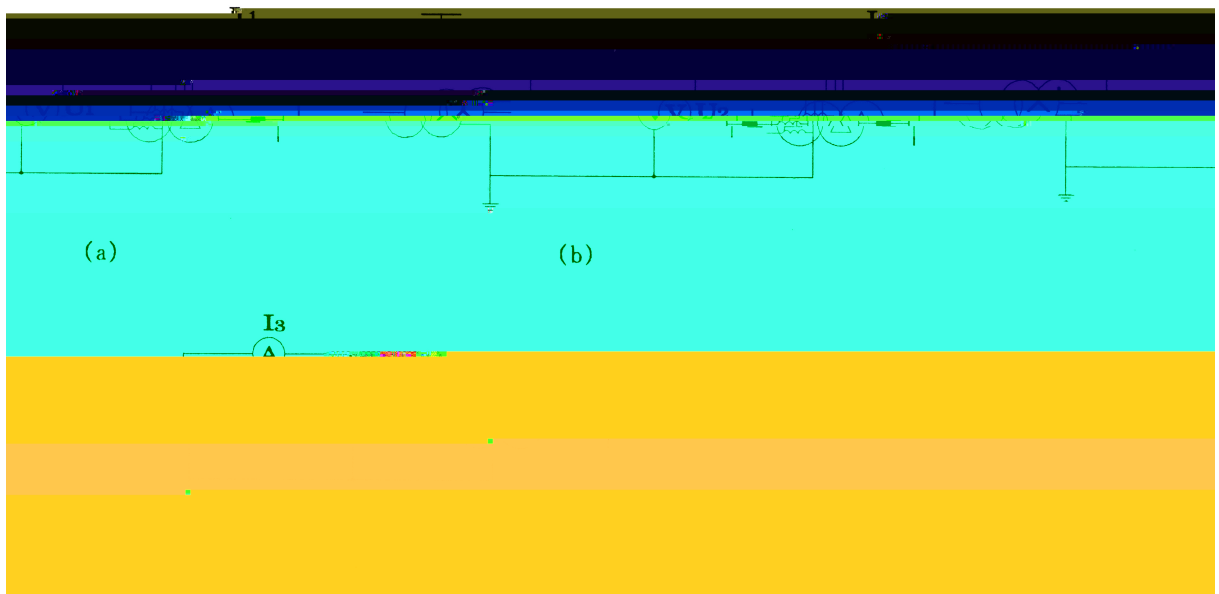

6% $M_{\#}N_{\#}$

fl V

$X_{\%}$ flU

$X_{\&}$

!

X

W

